

MDRXX

MICRO DYNAMIC RIFLE EXTREME

user manual



V3



DESERTTECH®
TOMORROWS WEAPONS

MDFR



MICRO DYNAMIC RIFLE EXTREME



YouTube



TABLE OF CONTENT

| | |
|---|----|
| SAFETY..... | 4 |
| WARNINGS..... | 4 |
| DT & MDRX PRESENTATION..... | 5 |
| BOX CONTENT..... | 6 |
| GUN DESCRIPTION..... | 6 |
| BATTERY INSTALLATION..... | 7 |
| MAGAZINE..... | 8 |
| SELECTOR..... | 9 |
| SHOOTING OPERATION..... | 9 |
| HOPUP ADJUSTMENT..... | 10 |
| ADVANCED SETTINGS & ERGONOMICS..... | 11 |
| EXPLODED VIEWS..... | 12 |
| MATERIALS / MASS / SIZE / CAPACITY..... | 13 |
| DIGITAL VERSION..... | 14 |

MDRX

Micro Dynamic Rifle extreme

V3

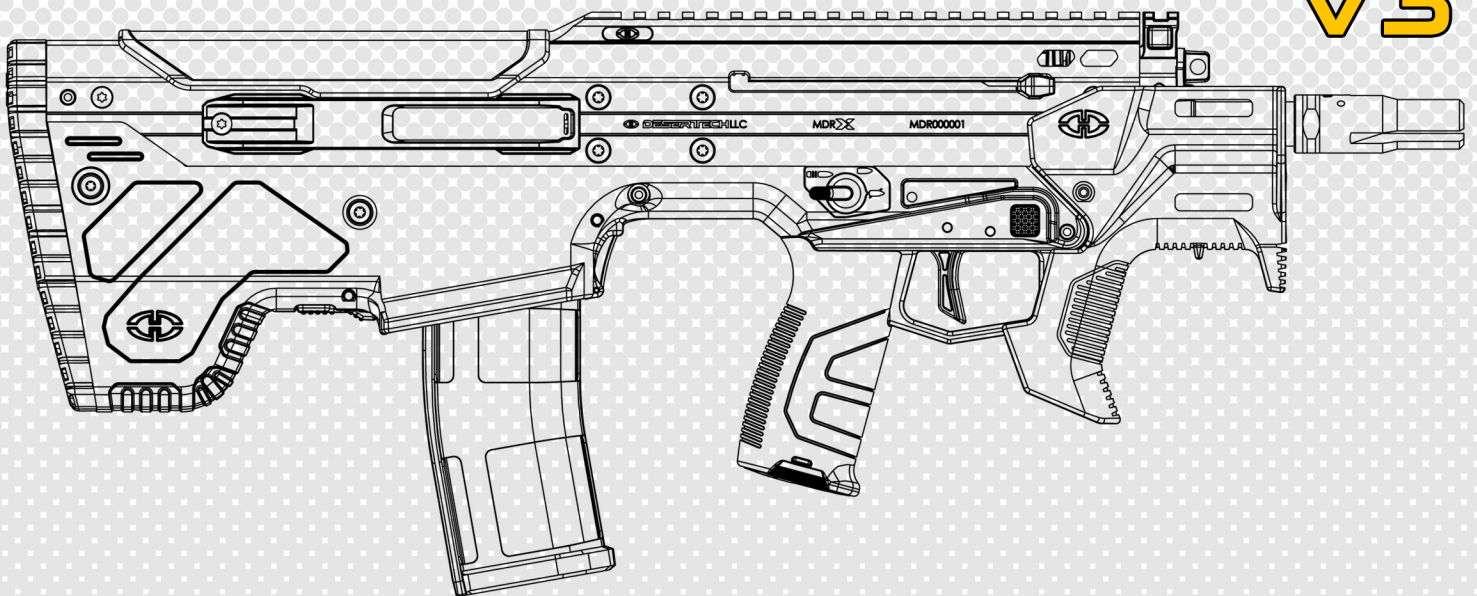

SAFETY

READ THIS MANUAL CAREFULLY AND THOROUGHLY BEFORE USE, users should obey to laws regarding the usage and ownership of airsoft guns in their country. Misuse or careless use may cause serious injuries. Always treat airsoft guns as if they are loaded and with the same respect as you would treat firearms. Do not look into an airsoft gun muzzle. Never point the airsoft gun at something you do not intend to shoot. Users should always wear safety glasses. Always carry the airsoft gun in a bag or a case and never display it in public places. Always keep the airsoft gun in "safe" mode until you are ready to shoot at a safe direction. Always check that the airsoft gun is in "safe" mode and unloaded when getting it from another person or from storage. Do not put the airsoft gun away or in storage while it is still loaded. Do not shoot at hard surfaces or water surfaces as bbs could bounce or ricochet and hit someone or something you do not intend to hit. Always use high quality 6mm plastic bbs and never use already shot bbs as it may damage your airsoft gun. Always store airsoft guns in a secure place and out of reach from children. Do not attempt to modify or alter your airsoft guns, as doing so may make your airsoft gun unsafe to use and/or cause serious injuries and/or void the warranty. **WE ARE NOT RESPONSIBLE FOR ANY MALFUNCTION, ACCIDENTS, INJURIES OR REPAIR COST RESULTING FROM MISUSE, DISASSEMBLY AND/OR MODIFICATION OF THIS AIRSOFT GUN.**



WARNINGS

- Make sure the battery is disconnected before making any checks or maintenances.
- Respect the polarity: red wire on red motor pole.
- Unplug the battery when the gun is not in use (for safety and battery drainage reasons).
- Take care of the cables when closing the lower receiver to avoid damaging them.
- If you remove the battery protection, you may damage your battery if you discharge it too much while shooting or keeping the battery connected for a long period of time.
- In case of jam (3 seconds beep) or malfunction, be sure to clear it before trying to shoot again.
- If the firing cycles are incomplete, it is time to recharge the battery.
- Do not overload the magazine or you will damage the magazine spring.
- Avoid to store the magazine fully loaded for a long period of time.
- Maximum torque for the 3 barrel screws is 3Nm. Excessive torque may damage the receiver, please refer to the exploded views.
- Do not apply any grease/oil inside the hopup and/or the barrel.
- By construction, the handguard is not precisely coaxial with the receiver, therefore the barrel could be off-centered in the handguard while being centered in the receiver. Optics must be attached to the gas-block or the receiver, not to the handguard.
- If used with pre-cocking, release the spring tension by pressing the anti reversal before to store the gun.
- If used with brushless motor, we do not recommend use of battery above 7.4V.
- If used with brushless motor, we suggest hi-torque setups over hi-speed setups.
- The use of a brushless motor may interfere with the proper functioning of certain options, such as pre-cocking.
- If you accidentally switch to PROGRAMMING MODE after pulling the trigger 5s in single mode, disconnect the battery to restart the ECU.

DESERTTECH®

◀ TOMORROWS WEAPONS ▶

Desert Tech, formerly Desert Tactical Arms, has been building a better rifle since 2007 when we realized the demands of future battlefields exceeded the capabilities of current platforms. We decided then to build our rifles more accurate, more compact, more convertible for an increasingly complex world.

Our R&D department is tasked daily to fuse ground-breaking engineering with American ingenuity so that skilled machinists on state-of-the-art mills and lathes can shape battle-tested materials into Tomorrow's Weapons. Each Desert Tech rifle that enters our network of nationwide dealers and international distributors is both ergonomically and ballistically superior to any other production rifle on the planet.

From concept to recoil, we are creating uncommon and uncompromising firearms with the sole intent of arming serious shooters to the very edge of their abilities and beyond. At Desert Tech, we're building Tomorrow's Weapons and it begins with a better rifle today.

The MDR is designed for future defense needs. Its compact size and superior ergonomics maximize its portability without sacrificing speed, power, or precision. The MDRX allows mission specific adaptability by changing the rifle's length, sound signature and/or caliber. Its fully ambidextrous design allows seamless shoulder transition.

The MDRX delivers advanced firepower for the future patriot.

Portable

The MDRX has unrivaled portability because it is lightweight, compact, ergonomic, and balanced with an overall length of 27.6" (702 mm) and a weight of 8.3 pounds (3.76 kg).

Adaptable

The MDRX is adaptable in both size and caliber. It can quickly convert between multiple calibers, and the barrel is truly free-floated by design so barrel whip does not affect accuracy.

Ambidextrous

The MDRX is fully ambidextrous with no modification necessary. Our patented forward ejection mechanism and intuitive controls set a new bullpup standard for speed and precision.

Multi Caliber

The MDRX can be converted within a few minutes to any of the available calibers.

Nicholas E Young



BOX CONTENT

- MDR-X airsoft replica (16" or Micron Version)
- User manual,
- polymer magazine (78 rds «7.62» or 120 rds «5.56»)
- SPR-1060 Spring (60 Newton)*,
- SPR-1100 Spring (100 Newton)*,
- Pin puncher,
- 2 mm & 5 mm Allen keys,
- High nub,
- Patch.

(*): Box content may vary depending on different countries regulations.

GUN DESCRIPTION

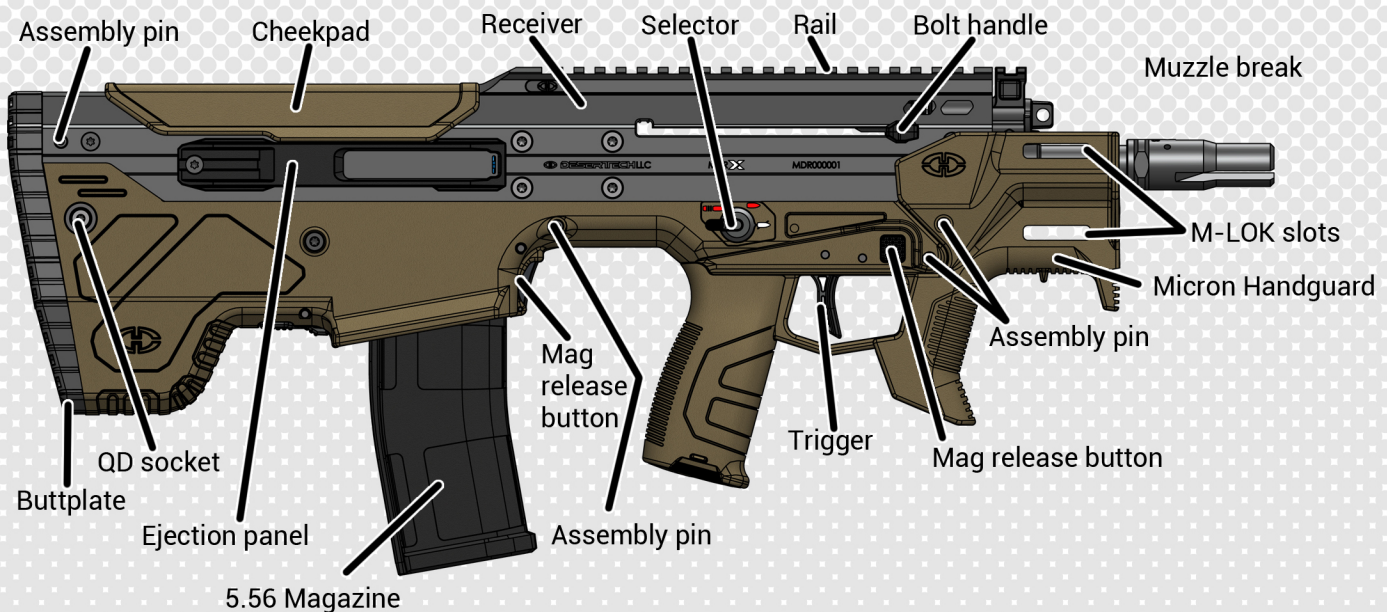
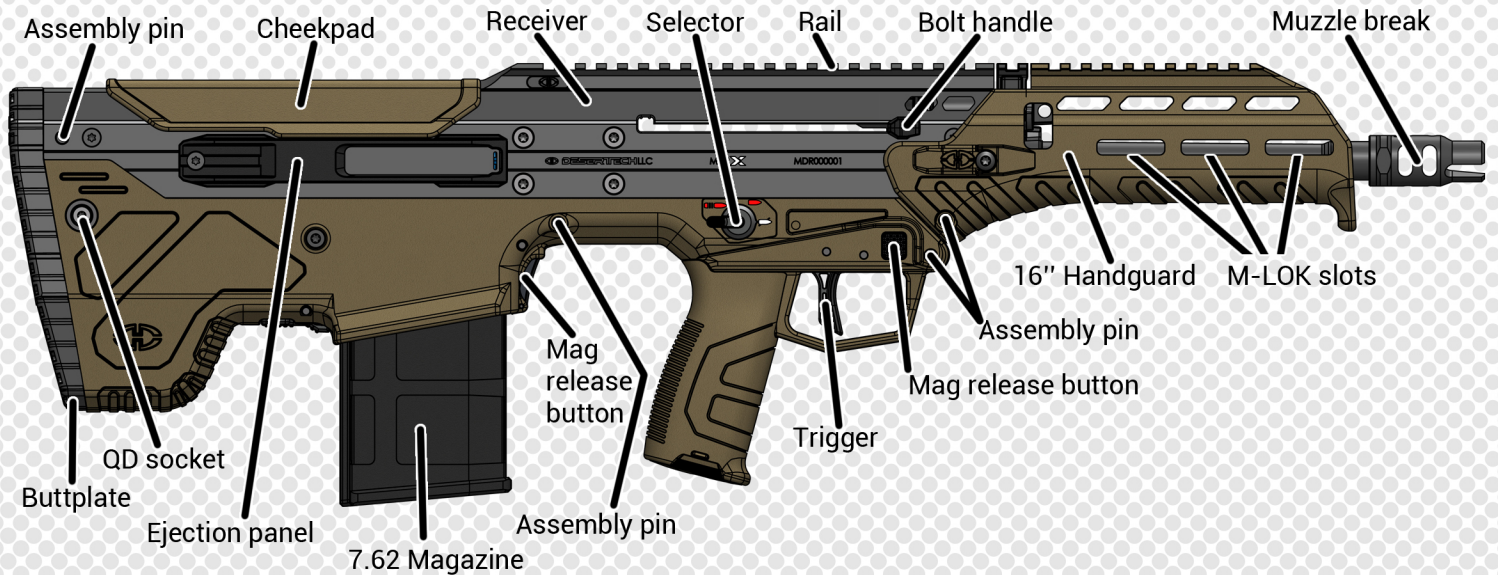

BATTERY INSTALLATION

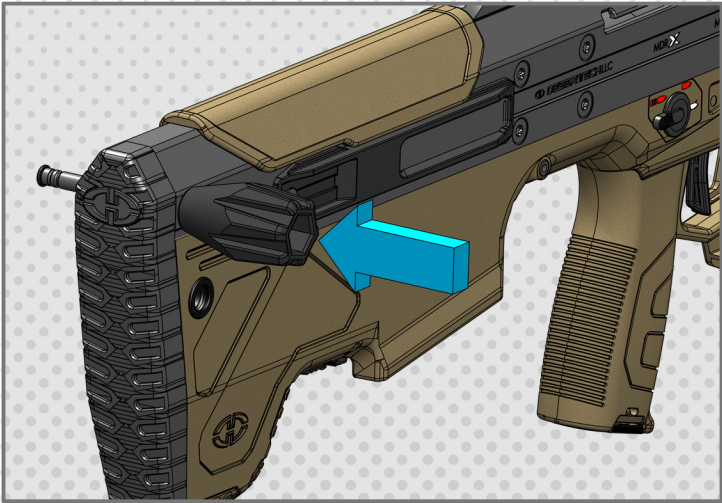

Punch out the assembly pin as shown using the provided pin-puncher.

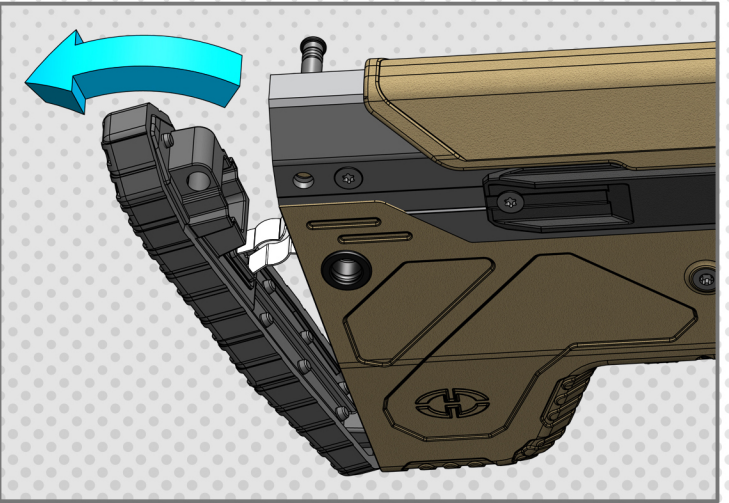

Remove the buttplate.

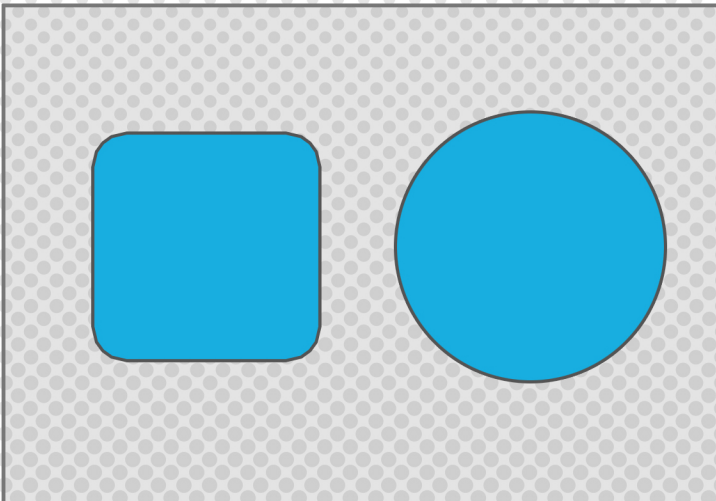

Maximum profile dimension for the battery:

- Square profile: 16 x 16 mm
- Circular profile: 17.5 mm diameter.

Maximum length: 190 mm.

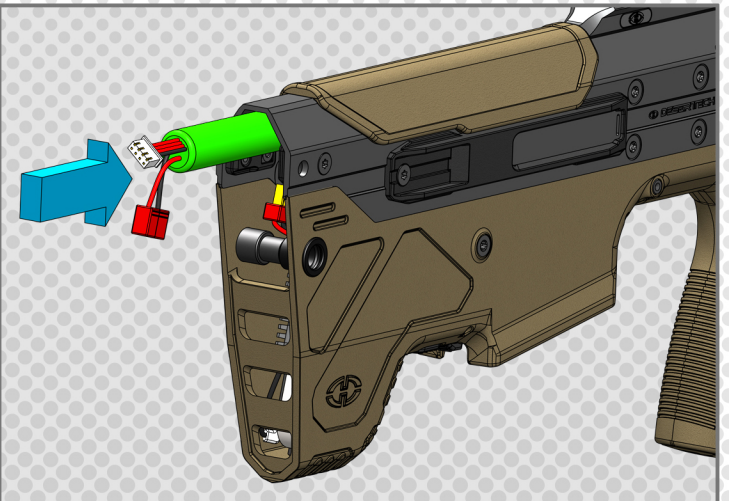

Slide the battery in the battery bay, between the gearbox cylinder and the receiver.

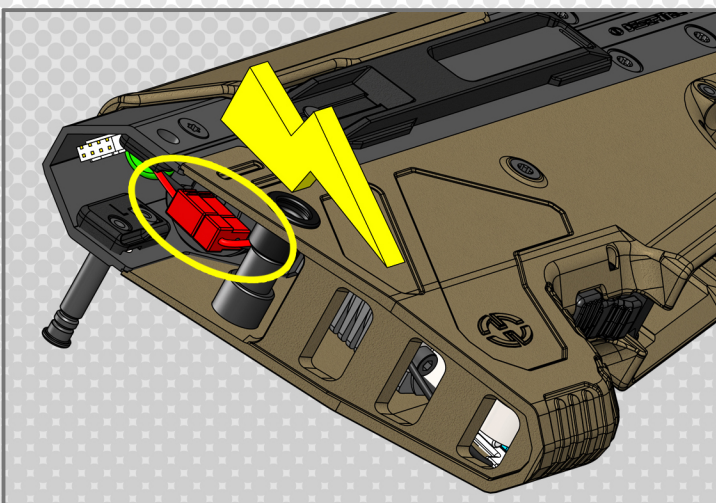

Connect the DEAN connectors, and store the cables inside the stock.

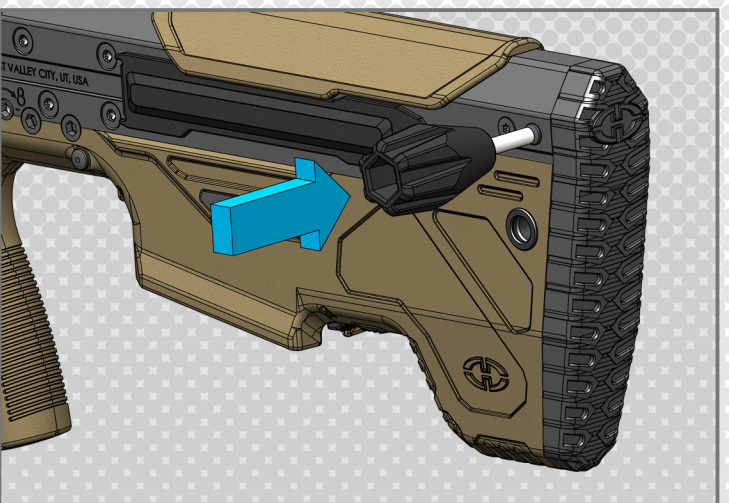

Replace the buttplate, and lock it with the assembly pin, using the provided pin-puncher. **WARNING:** make sure not to damage the cables when engaging the assembly pin.

MAGAZINE

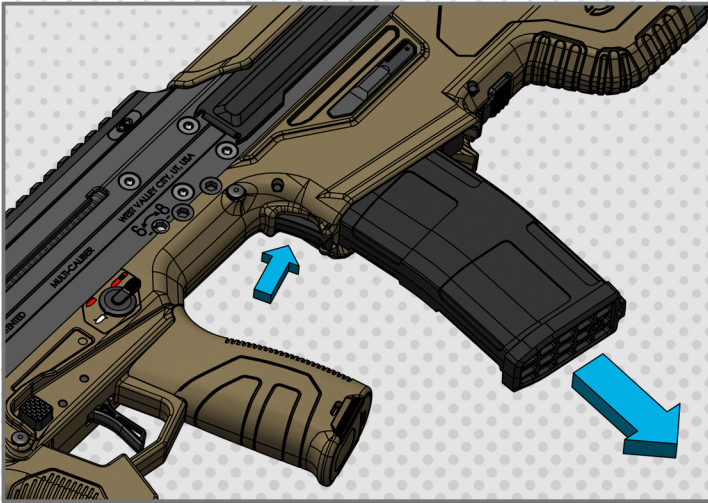

To remove the magazine, push down on the magcatch button and pull out the magazine.

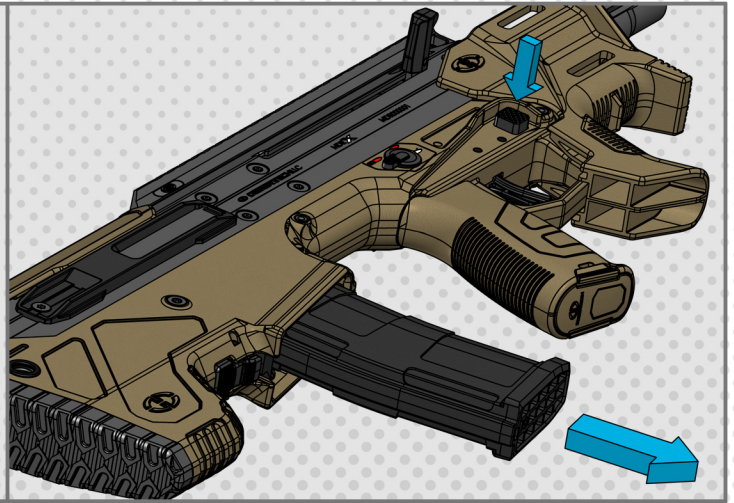

You can also remove the magazine by pressing the ambidextrous mag release button on the right side.

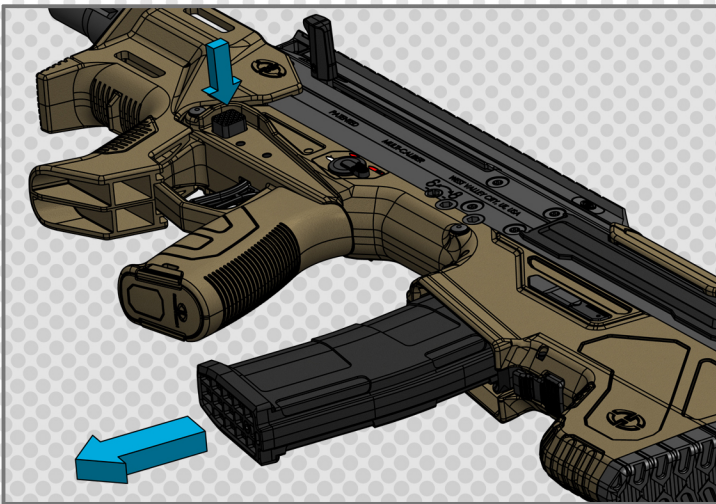

You can also remove the magazine by pressing the ambidextrous mag release button on the left side.

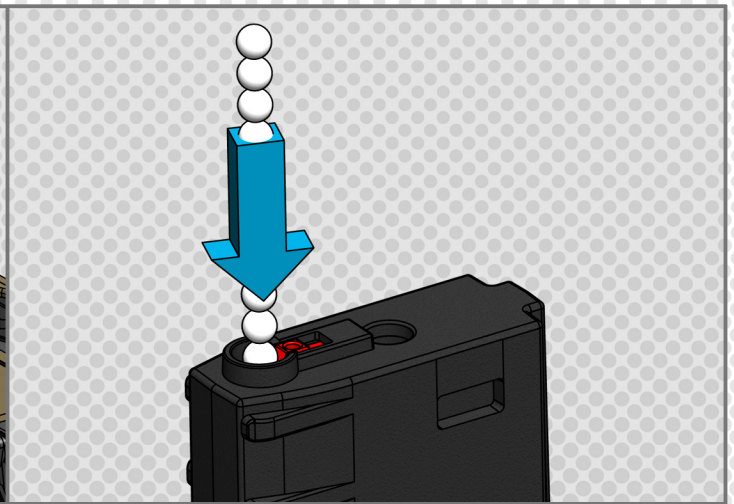

Load the magazine with a bb-loader (78 bbs capacity for the 7.62 magazine, 120 bbs for the 5.56 magazine).

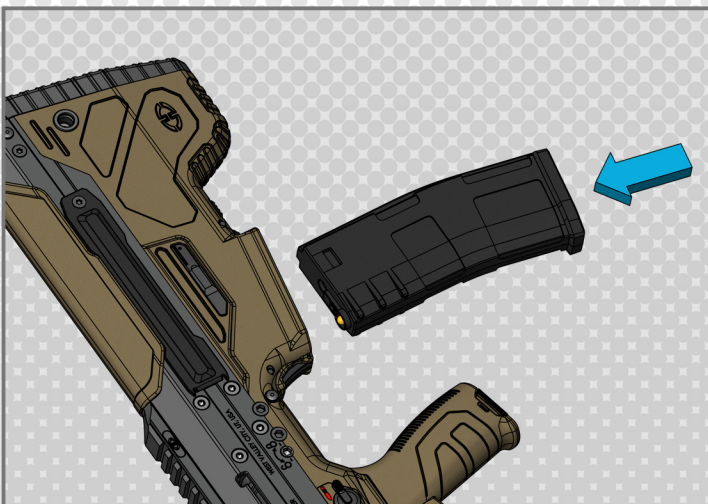

Insert the magazine firmly into the magwell until the magcatch locks it in place.

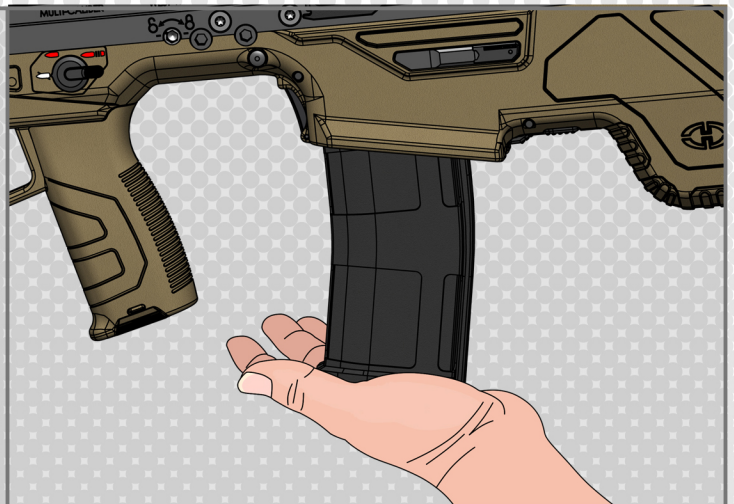

Slap the magazine and check to see that the magcatch is well engaged.

SELECTOR

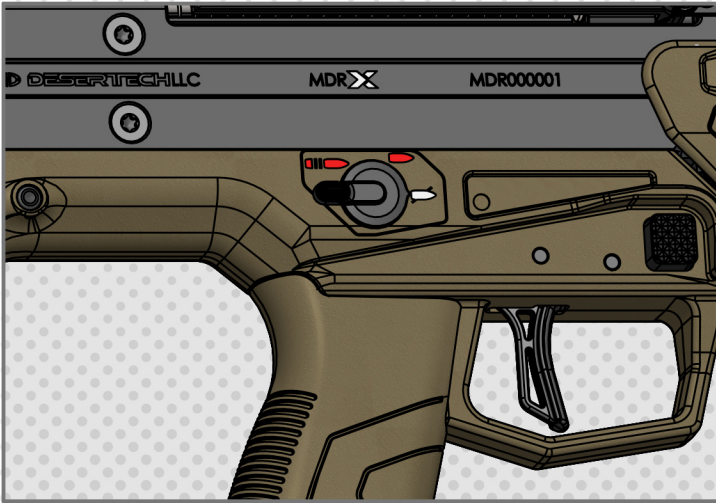

Safe mode, the trigger is mechanically locked and the gun cannot shoot.

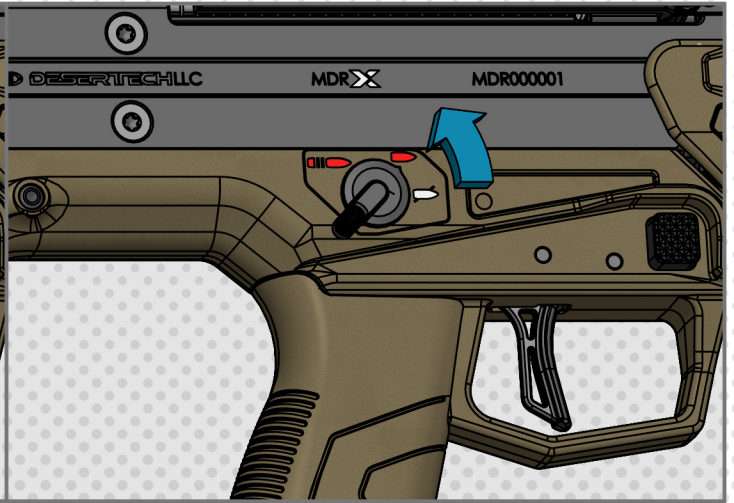

Semi-automatic mode, the gun will shoot once per trigger pull.

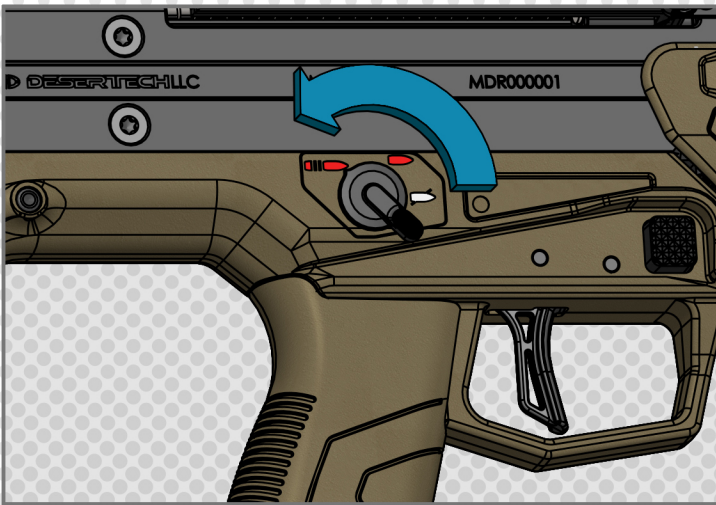

Full-automatic mode, the gun will shoot for as long as the trigger is pulled. NOTE: for the German market, full auto mode is disabled.

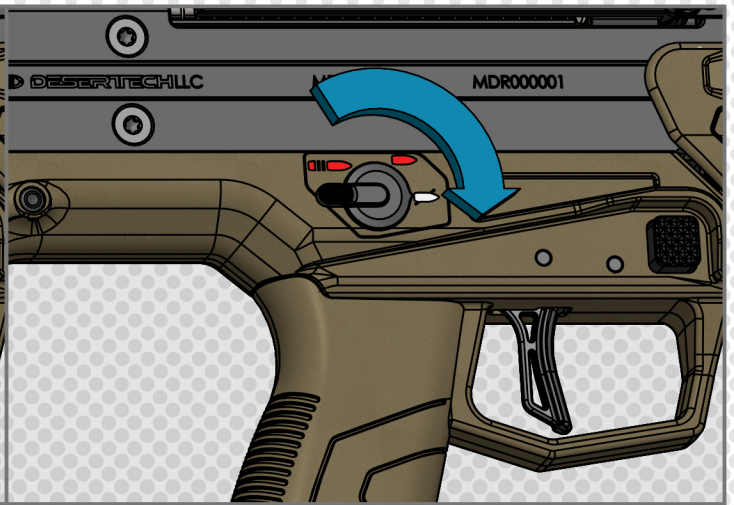

Always switch the selector to safe mode except if you intend to shoot.

SHOOTING OPERATION

Pull the trigger once to start the ECU, and wait 5 seconds to access the GAME mode.

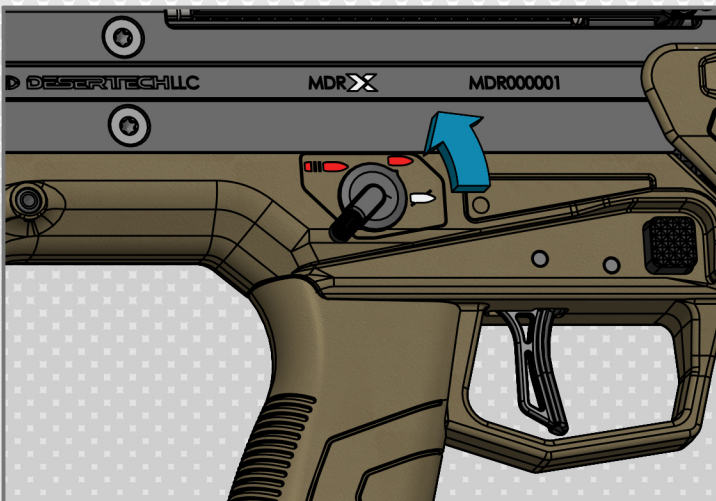

Turn the selector to one of the two firing modes.

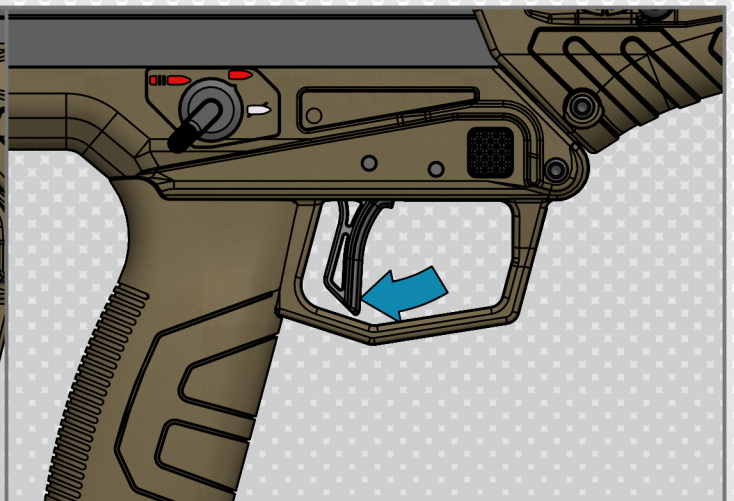

Pull the trigger to fire.

HOPUP ADJUSTMENT

Each «click» increases/decreases the hopup preload by about 21 μm . There are 36 positions for the hopup wheel, ranging from 0 up to 750 μm with the low nub (installed), and from 500 up to 1250 μm with the high nub (provided). Please refer to the dedicated video on our Youtube channel.

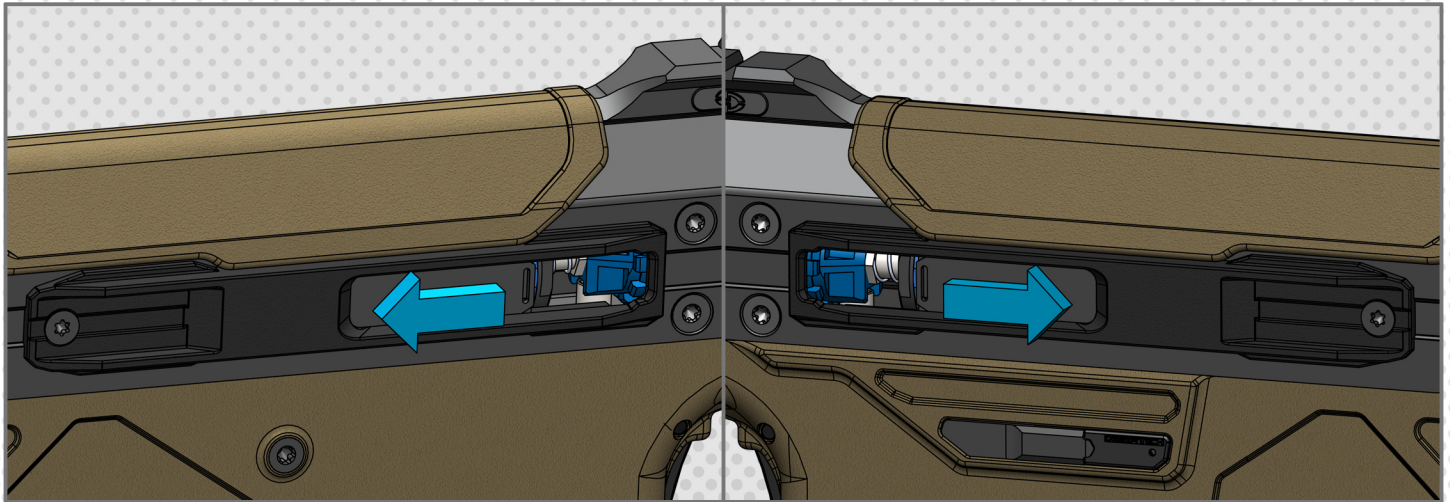

The Hopup can be accessed from the side ejection panel window.

If your gun is assembled for a left handed user, the Hopup access will be on the right side.

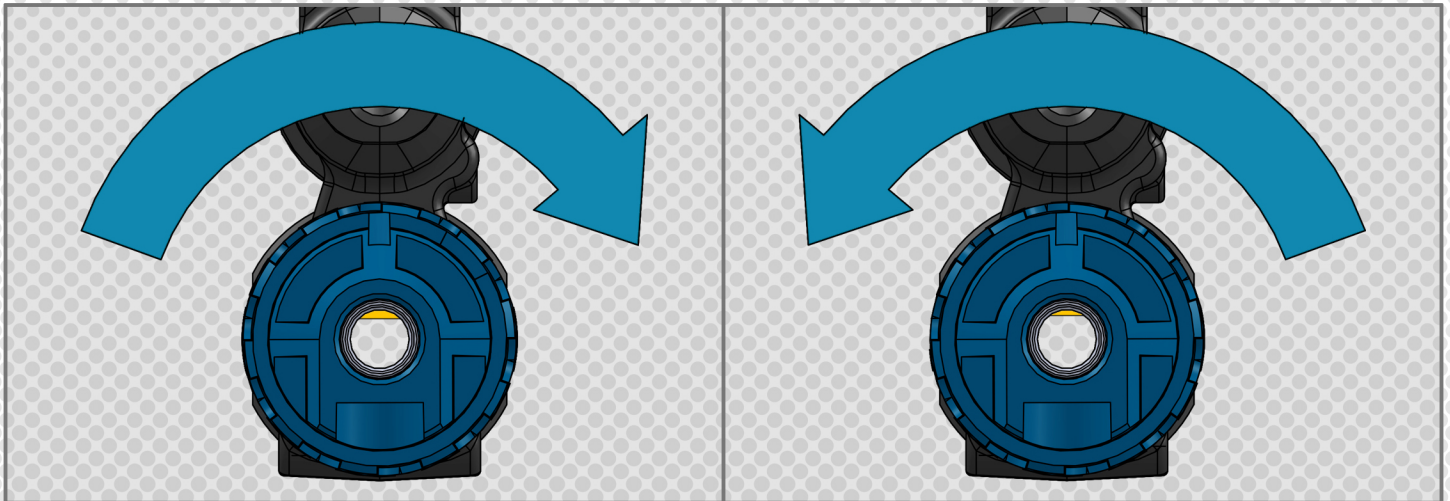

Turn the Hopup in clockwise direction to increase Hopup effect.

Turn the Hopup in counterclockwise direction to reduce Hopup effect.

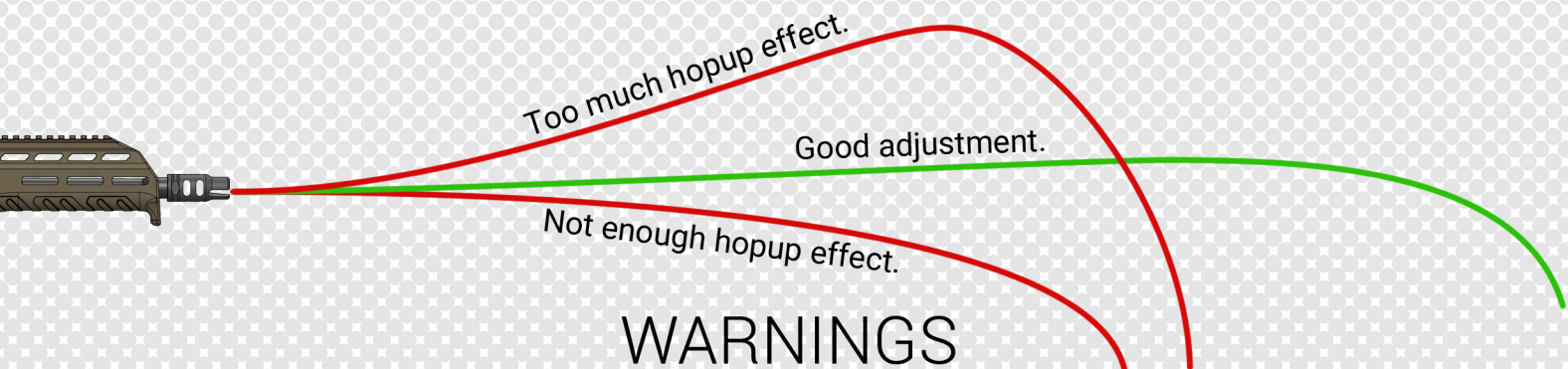

WARNINGS

- Hopup adjustment needs to be done every time you change the BBs mass or the muzzle energy.
- Excessive hopup adjustment will jam the gun.
- In case of jam:
 1. remove the magazine,
 2. turn the hopup wheel to minimal preload,
 3. shoot in a safe direction to clear the hopup,
 4. adjust the hopup again.
- Hopup adjustment may affect your muzzle energy: always check your muzzle energy after adjusting your hopup using in-game bbs and make sure it is within the limits of your local law/rules.
- It is mandatory to keep your hopup clean and dry to be effective.
- To avoid any sidespin, be sure to hold your rifle straight before to pull the trigger.

ADVANCED SETTINGS & ERGONOMICS

To help you with the ergonomics and advanced settings, please check out our YouTube channel for the video tutorials. Scan the QR code on this page to access our YouTube channel.

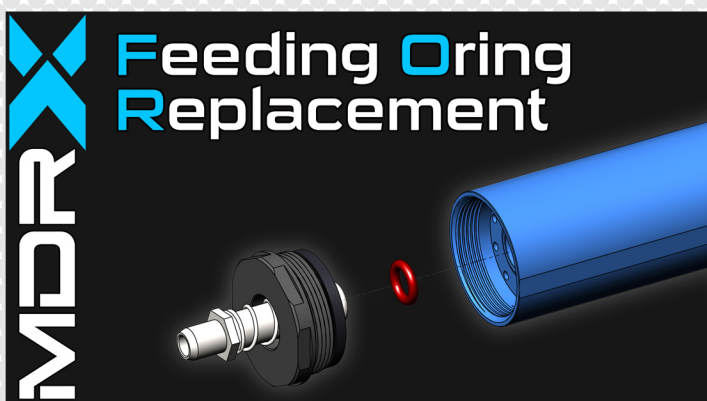
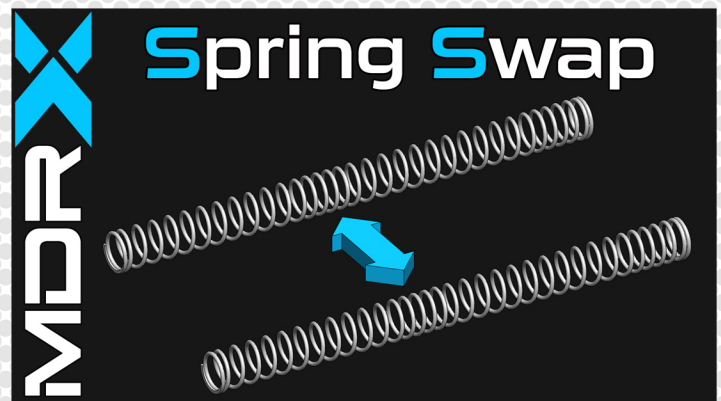
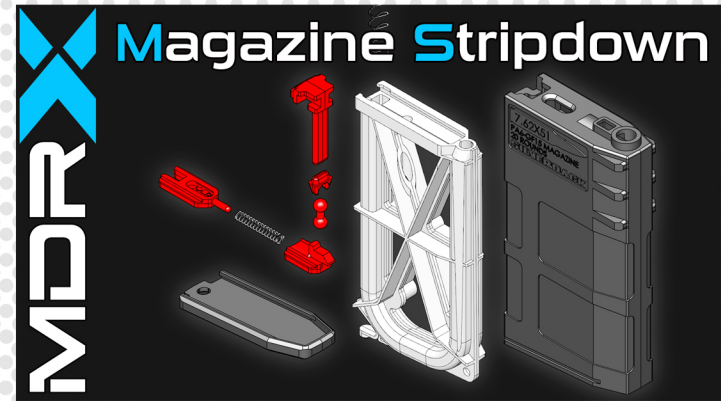
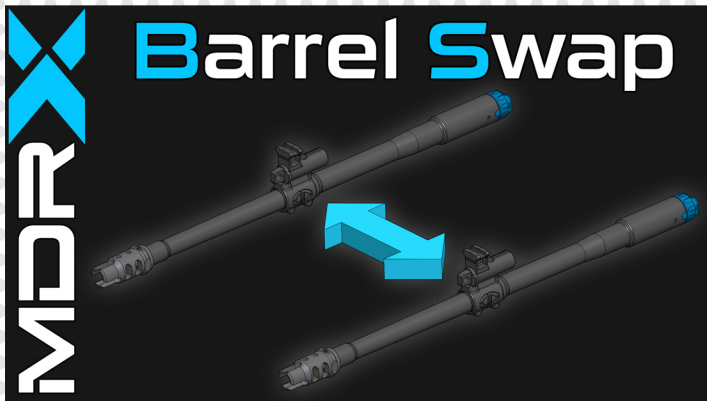
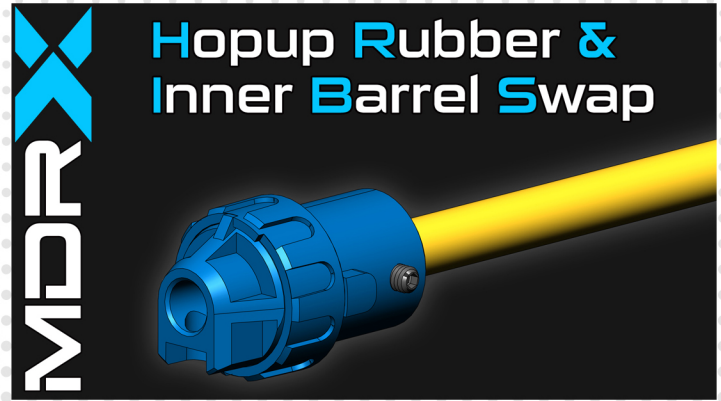

EXPLODED VIEWS



MDR-1500-02
MICRON HANDGUARD

MDR-0200-03
5.56 LOWER RECEIVER

Scan this QR code to access the MDRX Micron & MDRX 16\"/>

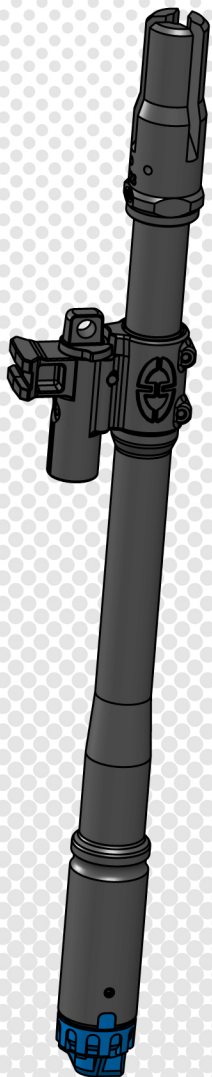
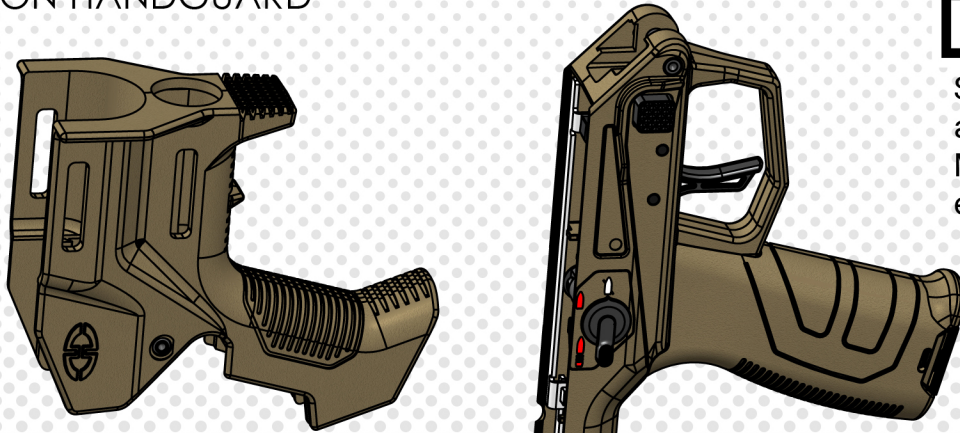

MDR-1300-04
MICRON
BARREL

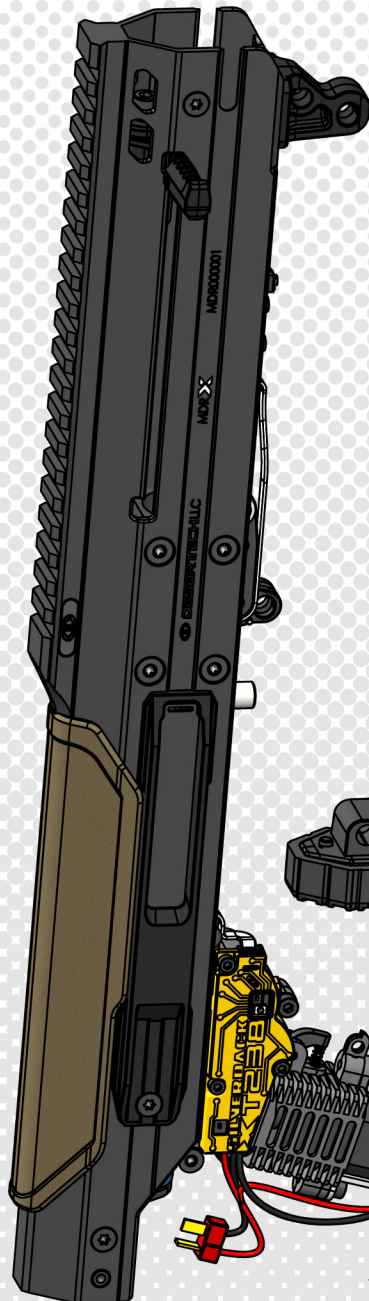

MDR-0100-04
5.56 UPPER RECEIVER

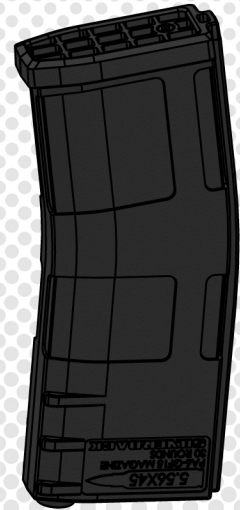

MDR-1900-04
5.56 MAGAZINE

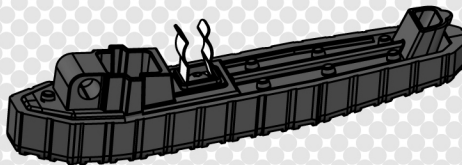

MDR-1400-01
BUTTPLATE



Scan this QR code to access the gearbox exploded views.

MATERIALS / MASS / SIZE / CAPACITY

| | buttplate | cylinder assembly | dummy bolt handle system | ejection panels | feeding tube | gearbox casing | gears | hardware | hopup | inner barrel | magazine | magazine release system | nozzle | orings | outer barrel assembly | PCB | piston | QD sockets | receiver | selector assembly | spring guide | springs | stock, grip & handguard | trigger assembly | trunnion assembly |
|-----------------------|-----------|-------------------|--------------------------|-----------------|--------------|----------------|-------|----------|-------|--------------|----------|-------------------------|--------|--------|-----------------------|-----|--------|------------|----------|-------------------|--------------|---------|-------------------------|------------------|-------------------|
| aluminium 6000 series | | | | | | | | | | | | | | | | | | | | | | | | | |
| aluminium ADC-12 | | | | | | | | | | | | | | | | | | | | | | | | | |
| steel CR1018 | | | | | | | | | | | | | | | | | | | | | | | | | |
| stainless steel SS304 | | | | | | | | | | | | | | | | | | | | | | | | | |
| steel 10.9 | | | | | | | | | | | | | | | | | | | | | | | | | |
| steel A228 | | | | | | | | | | | | | | | | | | | | | | | | | |
| MIM 4605 | | | | | | | | | | | | | | | | | | | | | | | | | |
| SNIT C11 | | | | | | | | | | | | | | | | | | | | | | | | | |
| brass | | | | | | | | | | | | | | | | | | | | | | | | | |
| nylon PA6-GF15 | | | | | | | | | | | | | | | | | | | | | | | | | |
| polycarbonate | | | | | | | | | | | | | | | | | | | | | | | | | |
| POM | | | | | | | | | | | | | | | | | | | | | | | | | |
| ABS | | | | | | | | | | | | | | | | | | | | | | | | | |
| NBR 70° / 80° | | | | | | | | | | | | | | | | | | | | | | | | | |
| silicone 70° | | | | | | | | | | | | | | | | | | | | | | | | | |
| FKM | | | | | | | | | | | | | | | | | | | | | | | | | |
| polyurethane | | | | | | | | | | | | | | | | | | | | | | | | | |

| ASSEMBLY # | ASSEMBLY NAME | [gram] |
|--------------------------------|---------------------|--------|
| MDR-0100-03 | 7.62 UPPER RECEIVER | 1313 |
| MDR-0100-04 | 5.56 UPPER RECEIVER | 1313 |
| MDR-0200-02 | 7.62 LOWER RECEIVER | 458 |
| MDR-0200-03 | 5.56 LOWER RECEIVER | 479 |
| MDR-1300-02 | 16" BARREL | 456 |
| MDR-1300-04 | MICRON BARREL | 405 |
| MDR-1400-01 | BUTTPLATE | 145 |
| MDR-1500-01 | 16" HANDGUARD | 120 |
| MDR-1500-02 | MICRON HANDGUARD | 130 |
| MDR-1800-02 | 7.62 MAGAZINE | 145 |
| MDR-1900-04 | 5.56 MAGAZINE | 184 |
| MDRX 16" | TOTAL | 2637 |
| MDRX Micron | TOTAL | 2656 |
| <i>Mass tolerances: +/- 3%</i> | | |

| SIZE | [mm] |
|----------------------------------|------|
| MDRX 16" | 702 |
| 16" inner barrel (AEG type) | 420 |
| MDRX Micron | 602 |
| Micron inner barrel (AEG type) | 330 |
| <i>Size tolerances: +/- 0.2%</i> | |

| CAPACITY | [bbs] |
|---------------|-------|
| 7.62 magazine | 78 |
| 5.56 magazine | 120 |
| Feeding tube | 4 |

DIGITAL VERSION

Scan this QR code and download the digital version of the user manual. In case of user manual updates, this link will provide you with the latest version.



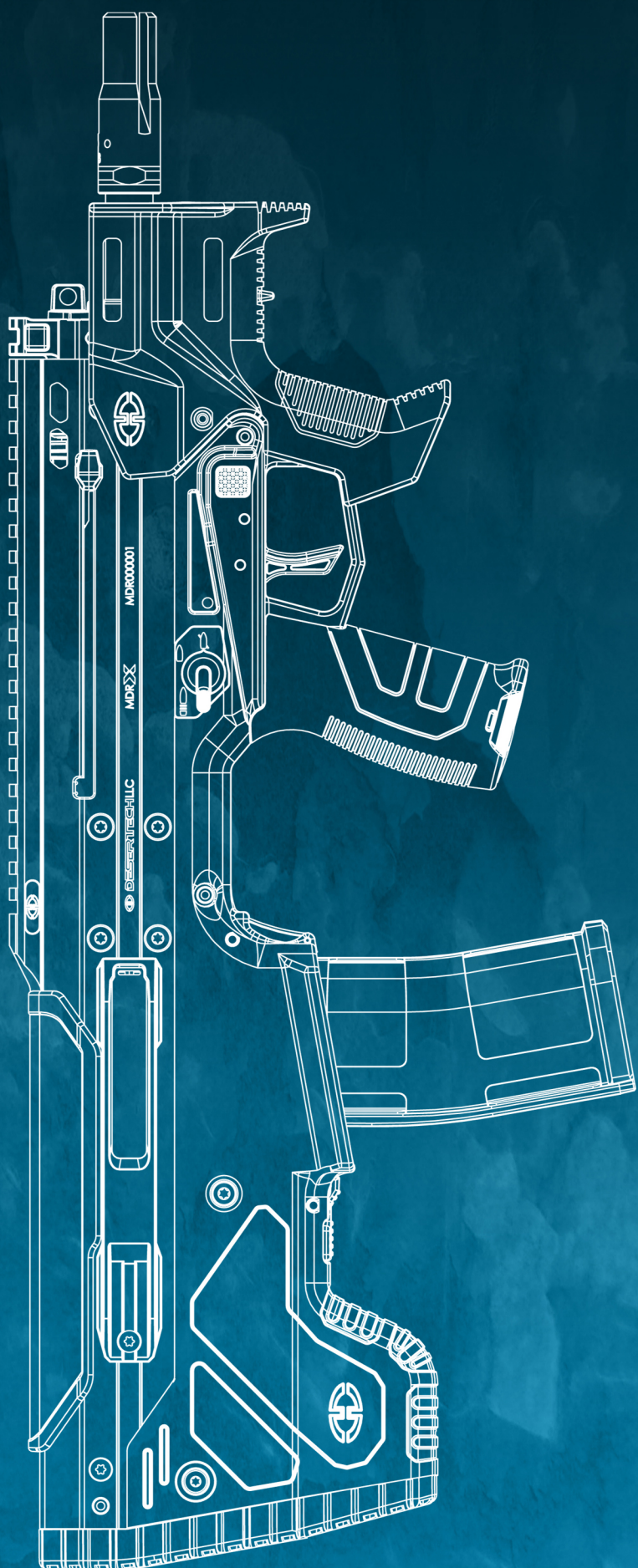
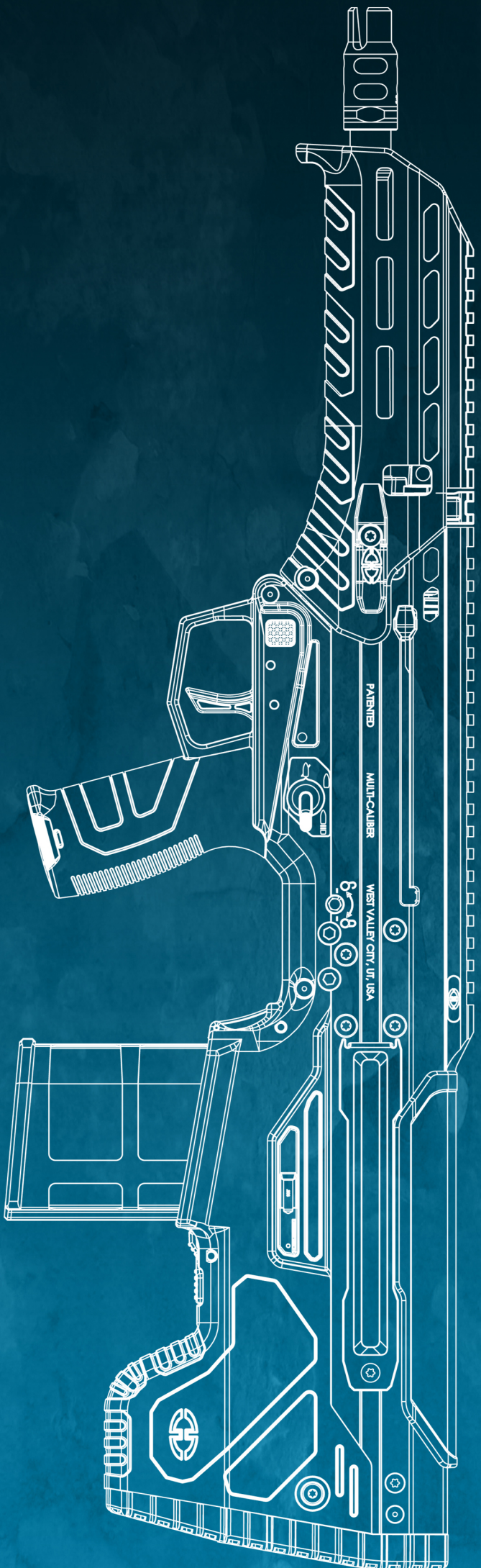



September 2024 - Made in China

SILNERBACK AIRSOFT